

eliwell

EW Plus 902/961/971/974

EN

IT



DE

FR

Electronic controllers for refrigeration units
Controllori elettronici per unità refrigeranti
Elektronische Regler für Kühleinheiten
Contrôleurs électroniques pour unités réfrigérantes

eliwell

Eliwell Controls s.r.l.

Via dell'Industria, 15 • Z.I. Paludi
32010 Pieve d'Alpago (BL) ITALY
Telephone +39 0437 986 111
Facsimile +39 0437 989 066
www.eliwell.it

Technical Customer Support:

Technical helpline +39 0437 986 300
E-mail: techsuppliwell@invensys.com

Sales

Telephone +39 0437 986 100 (Italy)
+39 0437 986 200 (other countries)
E-mail: saleseliwell@invensys.com



ISO 9001



cod. 9IS54151 - EW Plus 902/961/971/974 - EN-IT-DE-FR - rel. 04/10

© Eliwell Controls s.r.l. 2009-2010 All rights reserved.

Electronic controllers for refrigeration units







EW^{PLUS} 902/961







EW^{PLUS} 971/974

KEYS

 <p>UP Press and release Scrolls through menu items Increases values Press for at least 5 secs Activates the Manual Defrost function</p>	 <p>STAND-BY (ESC) Press and release Returns to the previous menu level Confirm parameter value Press for at least 5 secs Activates the Stand-by function (when outside the menus)</p>
 <p>DOWN Press and release Scrolls through menu items Decreases values Press for at least 5 secs Configurable function by user (par.H32)</p>	 <p>SET (ENTER) Press and release Displays alarms (if active) Opens the Machine Status menu Press for at least 5 secs Opens the Programming menu Confirms commands</p>

LEDs

 <p>Reduced SET / Economy Flashing: reduced set active Quick flashing: access to level 2 parameters Off: otherwise</p>	 <p>Fan LED Permanently on: fans active Off: otherwise (only EW Plus 971 and EW Plus 974)</p>
 <p>Compressor LED Permanently on: compressor active Flashing: delay, protection or blocked start-up Off: otherwise</p>	<p>AUX Aux LED Permanently on: Aux active* *depending on model (only EW Plus 971 and EW Plus 974)</p>
 <p>Defrost LED Permanently on: defrost active Flashing: manual or D.I. activation Off: otherwise</p>	<p>1 HEAT mode LED Permanently on: compressor in HEAT mode Off: otherwise (only EW Plus 902 and EW Plus 961)</p>
<p>°C °C LED Permanently on: °C setting (dro = 0) Off: otherwise</p>	<p>NOTE: If the instrument is set in the COOL mode, in order to use it in the HEAT mode it is necessary to re-programme the instrument by using the properly programmed Copycard. The same procedure should be followed to pass from the HEAT mode to the COOL mode.</p>
<p>°F °F LED Permanently on: °F setting (dro = 1) Off: otherwise</p>	
 <p>Alarm LED Permanently on: alarm on Flashing: alarm acknowledged Off: otherwise</p>	

2 NOT USED
(only EW Plus 902 and EW Plus 961)

ACCESSING AND USING THE MENUS

Resources are organised into 2 menus which are accessed as explained below:

- 'Machine Status' menu: press and release the **set** key.
- 'Programming' menu: press for at least 5 secs the **set** key.

Either do not press any keys for 15 seconds (time-out) or press the **⏸** key once, to confirm the last value displayed and return to the previous screen.

MACHINE STATUS MENU

Access the "Machine Status" menu by pressing and releasing the **set** key. If no alarms are active, the "SEt" label appears. By pressing the **⏶** and **⏷** keys you can scroll all folders in the "Machine Status" menu:

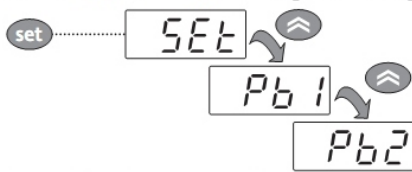

- AL: alarms folder (**only visible if an alarm is active**);
- SEt: Set point setting folder;
- Pb1: probe 1 folder;
- Pb2: probe 2 folder **;

(** models EW Plus 971 and EW Plus 974 only)

Setting the Set point: To display the Set point value press the **set** key when the 'SEt' label is displayed.

The Set point value appears on the display. To change the Set point value, press the **⏶** and **⏷** keys within 15 seconds. Press **set** to confirm the modification.



Displaying the probes: When the Pb1 or Pb2* label is displayed, press **set** and the associated probe value will appear (* Pb2 is only present on models EW Plus 971 and EW Plus 974).

SET POINT EDIT LOCK

It is possible to disable the keypad on this device. The keypad can be locked by programming the 'LOC' parameter. With the keypad locked you can still access the 'Machine Status' menu by pressing **set** to display the Set point, but you cannot edit them. To disable the keypad lock, repeat the locking procedure.

PROGRAMMING MENU

To access the 'Programming' menu press for at least 5 secs the **set** key. If specified, the 'PA1' for the level 1 parameters and the 'PA2' for the level 2 parameters access PASSWORD will be requested (see Par. 'PASSWORD') At the access, the display will show the first parameter ("diF"). By pressing the **⏶** and **⏷** keys you can scroll all parameters in the current level:

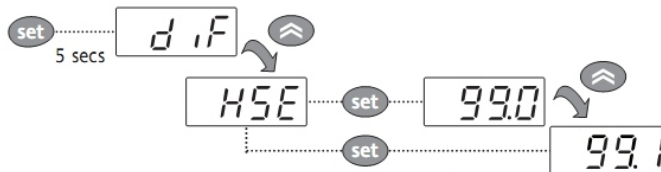

Select the desired parameter using the **⏶** and **⏷** keys. Press **set** to see the current value of the selected parameter. Press **⏶** and **⏷** to change the value and then press **set** to save it.

NOTE: It is strongly recommended that you switch the device off and on again each time the parameter configuration is changed, in order to prevent malfunctioning of the configuration and/or ongoing timings.

PASSWORD

'PA1' Password:

it allows to access to the level 1 parameters. In the standard configuration the password is disabled (value = 0). To enable it (value \neq 0) enter the "Programming" menu by pressing the **⏶** and **⏷** keys, scroll the parameters until "PS1" label is displayed, press the **set** key to display the current value, change it by using the **⏶** and **⏷** keys and then press the **set** key to save it. If the password is already enabled, you will be required to enter it to access the 'Programming' menu. To enter it:



'PA2' Password:

it allows to access to the level 2 parameters. In the standard configuration the password is enabled (valore \neq 0). To change its value follow the steps like for 'PA1' and change the 'PS2' parameter value. The visibility of the 'PA2' label will be:

- 1) If **PA1** and **PA2** \neq 0: By pressing the **set** key for more than 5 seconds, "PA1" and "PA2" labels will be displayed at the same level and it will be possible to access either the level 1 or the level 2 parameters.
- 2) **Otherwise:** The 'PA2' password is present between the level 1 parameters. If 'PA2' is enabled, you will be required to enter it to access the level 2. To enter it follow the steps described for the 'PA1' password

If the password is incorrect, the instruments display the PA1/PA2 label and you will have to repeat the entry procedure.

ALARMS

Label	Fault	Cause	Effects	Remedy
E1	Probe1 faulty (cold room)	<ul style="list-style-type: none"> reading of out of range operating values probe faulty / short-circuited / open 	<ul style="list-style-type: none"> Display label E1 Alarm icon permanently ON Min/max alarm regulator disabled Compressor operation according to "Ont" and "OFt" parameters. 	<ul style="list-style-type: none"> check probe type (NTC) check the probe wiring replace probe
E2	Probe2 faulty (defrost)	<ul style="list-style-type: none"> reading of out of range operating values probe faulty / short-circuited / open 	<ul style="list-style-type: none"> Display label E2 Alarm icon permanently ON The defrost cycle will end due to Time out (Parameter "dEt") 	<ul style="list-style-type: none"> check probe type (NTC) check the probe wiring replace probe
AH1	Probe1 HIGH Temperature alarm	<ul style="list-style-type: none"> value read by Pb1 > HAL after time of "tAO". (see "MAX/MIN TEMP. ALARMS") 	<ul style="list-style-type: none"> Registration AH1 label in the AL folder No effect on regulation 	<ul style="list-style-type: none"> Wait until temperature value read by probe1 returns below HAL.
AL1	Probe1 LOW Temperature alarm	<ul style="list-style-type: none"> value read by Pb1 < LAL after time of "tAO". (see "MAX/MIN TEMP. ALARMS") 	<ul style="list-style-type: none"> Registration AL1 label in the AL folder No effect on regulation 	<ul style="list-style-type: none"> Wait until temperature value read by probe1 to come back above LAL
EA	External alarm	<ul style="list-style-type: none"> Digital input activated (H11 = ±5) 	<ul style="list-style-type: none"> Registration EA label in the AL folder Alarm icon permanently ON Regulation blocked if EAL = y 	<ul style="list-style-type: none"> check and remove the external cause which generate alarm on D.I.
OPd	Door Open alarm	<ul style="list-style-type: none"> Digital input activated (H11 = ±4) (for a longer time than td0) 	<ul style="list-style-type: none"> Registration OPd label in the AL folder Alarm icon permanently ON Regulator blocked 	<ul style="list-style-type: none"> close the door delay function defined by OAO
Ad2	Defrosting for time-out	<ul style="list-style-type: none"> end of defrosting because of time instead of because of reaching the defrost end temperature detected by the Pb2 probe. 	<ul style="list-style-type: none"> Registration Ad2 label in the AL folder Alarm icon permanently ON 	<ul style="list-style-type: none"> wait until the next defrost for automatic return

MANUAL DEFROST CYCLE ACTIVATION

To manually activate the defrost cycle, hold down the  key for 5 seconds.

If the defrost conditions are not satisfied:

- the parameter OdO ≠ 0 (**EW Plus 902/961/971/974**)

- the evaporator probe Pb2 temperature is higher than the defrost end temperature (**EW Plus 971/974**)

the display will flash 3 times, to indicate that the operation will not be carried out.

DIAGNOSTICS

Alarms are always indicated by the buzzer (if present) and the alarm icon (⦿).

To switch off the buzzer, press and release any key, the relative icon will continue to flash.

NOTES: If alarm exclusion times have been set (see 'AL' folder in the parameters table) the alarm will not be signalled.

A probe 1 (Pb1) malfunction alarm will appear directly on the display with the indication E1.

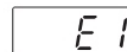

Models EW Plus 971/974: A probe 2 (Pb2) malfunction alarm will appear directly on the display with the indication E2.

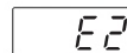

MECHANICAL ASSEMBLY

The instrument is designed for panel mounting. Make a hole of 29x71 mm, insert the instrument and fix it using the brackets provided. Do not mount the instrument in humid and/or dirty places; it is suitable for use in ordinary polluted places. Ventilate the place in proximity to the instrument cooling slits.

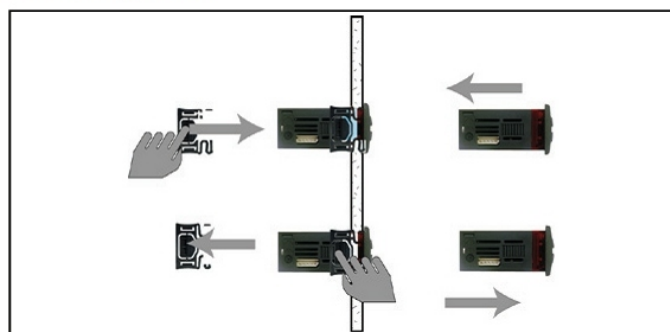
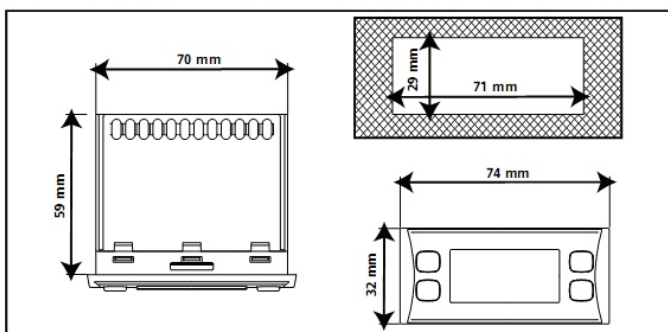

USING THE COPY CARD

The Copy Card is an accessory connected to the TTL serial port used for quick programming of the device parameters (upload and download a parameter map to one or more devices of the same type). Upload (label UL) and copy card formatting (label Fr) operations should be performed as explained below:

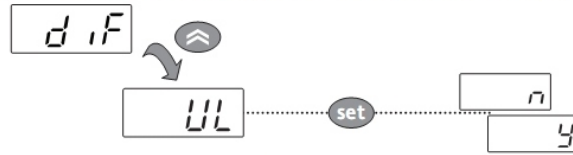

After the password 'PA2' has been putted in, press the and keys to scroll through to the required function (e.g. UL). Press the key to execute the upload. If the operation is successful, the display will show 'y', if not it will show 'n'.

Upload (UL) This function uploads the programming parameters from the device.

UPLOAD: device \longrightarrow Copy Card

Format (Fr) This command is used to format the copy card, an operation which is necessary when using the card for the first time. **Important:** when the copy card has been programmed, the parameter 'Fr' will delete all data that have been entered. This operation cannot be cancelled.

Download from reset:

Connect the copy card when the device is switched off. When the device is switched on, the download from the copy card will begin automatically. At the end of the lamp test, the display will show 'dLy' if the operation was successful and 'dLn' if not.



DOWNLOAD: Copy Card \longrightarrow device

NOTES:

- after the parameters have been downloaded, the device uses the downloaded parameter map settings.

MAX/MIN TEMPERATURE ALARM

Relative Temperature Value to setpoint (Att=1)

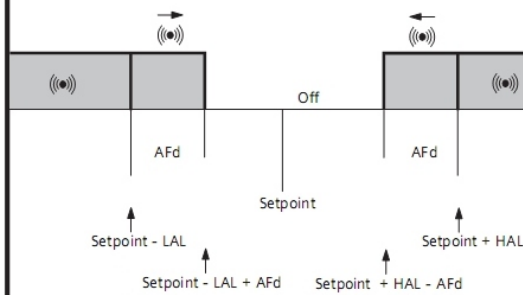

Minimum temperature alarm

Temp. \leq Set + LAL *

Maximum temperature alarm

Temp. \geq Set + HAL **

Returning from minimum temp. alarm

Temp. \geq Set + LAL + AFd or
 \geq Set - |LAL| + AFd (LAL < 0)

Returning from maximum temp. alarm

Temp. \leq Set + HAL - AFd (HAL > 0)

Absolute Temperature Value (Att=0)

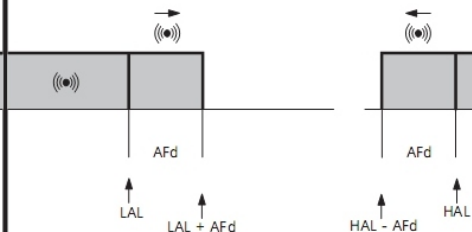

Temp. \leq LAL (LAL with sign)

Temp. \geq HAL (HAL with sign)

Temp. \geq LAL + AFd

Temp. \leq HAL - AFd

* if LAL is negative, Set + LAL < Set

** if HAL is negative, Set + HAL < Set

ELECTRICAL WIRING

Attention! Never work on electrical connections when the machine is switched on.

The device is equipped with screw or removable terminals for connecting electric cables with a diameter of 2.5mm² (one wire per terminal for power connections).

For the capacity of the terminals, see the label on the instrument.

Do not exceed the maximum current allowed; in case of higher loads, use an appropriate contactor.

Make sure the power supply voltage complies with the one required by the instrument.

Probes have no connection polarity and can be extended using a regular bipolar cable (note that the extension of the probes affects the EMC electromagnetic compatibility of the instrument: pay extreme attention to wiring).

Probe cables, power supply cables and the TTL serial cables should be distant from power cables.

RESPONSIBILITY AND RESIDUAL RISKS

ELIWELL CONTROLS SRL shall not be liable for any damages deriving from:

- installation/use other than that prescribed and, in particular, that which does not comply with safety standards anticipated by regulations and/or those given herein;
- use on boards which do not guarantee adequate protection against electric shock, water or dust under the conditions of assembly applied;
- use on boards which allow access to dangerous parts without the use of tools;
- tampering with and/or alteration of the products;
- installation/use on boards that do not comply with the standards and regulations in force.

DISCLAIMER

This manual and its contents remain the sole property of ELIWELL CONTROLS SRL, and shall not be reproduced or distributed without authorization by ELIWELL CONTROLS SRL.

Although great care has been exercised in the preparation of this document, ELIWELL CONTROLS SRL, its employees or its vendors, cannot accept any liability whatsoever connected with its use.

The same applies to any person or company involved in preparing and editing this document.

ELIWELL CONTROLS SRL reserves the right to make any changes or improvements without prior notice.

CONDITIONS OF USE

Permitted use

For safety reasons the instrument must be installed and used according to the instruction provided and in particular, under normal conditions, parts bearing dangerous voltage levels must not be accessible. The device must be adequately protected from water and dust as per the application and must also only be accessible via the use of tools (with the exception of the frontlet).

The device is ideally suited for use on household appliances and/or similar refrigeration equipment and has been tested with regard to the aspects concerning European reference standards on safety.

Unpermitted use

Any other use other than that permitted is de facto prohibited. It should be noted that the relay contacts provided are of a practical type and therefore subject to fault. Any protection devices required by product standards or dictated by common sense due to obvious safety reasons should be applied externally.

TECHNICAL DATA (EN 60730-2-9)

Classification:	control device (not safety) to integrate
Mounting:	panel mounting with 71x29 mm (+0.2/-0.1 mm) drilling template
Control type:	1.B
Pollution rating:	2
Material class:	IIIa
Overvoltage category class:	II
Nominal impulsive voltage:	2500V
Temperature:	Operating: -5 ... +55 °C - Storage: -30 ... +85 °C
Power Supply:	230Vac (+10% / -10%) 50/60 Hz
Consumption:	4,5W max
Digital Output (relays):	please refer to the device label
Fire resistance class:	D
Software class:	A

NOTA: check the power supply specified on the instrument label; for relay, power supply capacities and PTC probes, contact the Sales Office.

FURTHER INFORMATIONS

Input Characteristics

Display Range:	NTC: -50.0°C ... +110°C; PTC: -55.0°C ... +140°C (on display with 3 digit + sign)
Accuracy:	Better than 0,5% of full-scale + 1 digit
Resolution:	0,1 °C
Buzzer:	YES (it depends from model)
Analogue Input:	EW Plus 902/961: 1 NTC input EW Plus 971/974: 2 NTC inputs
Digital Input:	1 voltage-free digital input

Output Characteristics

Digital Output:	EW Plus 902: 1 OUT1 relay: N.O. 8(4)A - N.C. 6(3)A max 250Vac
	EW Plus 961: 1 Compressor relay: UL60730 (A) 2Hp (12FLA - 72LRA) max 240Vac or UL60730 (A) 12(12)A max 250Vac
	EW Plus 971: 1 Defrost relay: N.O. 8(4)A - N.C. 6(3)A max 250Vac 1 Compressor relay: UL60730 (A) 2Hp (12FLA - 72LRA) max 240Vac or UL60730 (A) 12(12)A max 250Vac
	EW Plus 974: 1 Defrost relay: N.O. 8(4)A - N.C. 6(3)A max 250Vac 1 Compressor relay: UL60730 (A) 2Hp (12FLA - 72LRA) max 240Vac or UL60730 (A) 12(12)A max 250Vac 1 Fan relay: 5(2)A max 250Vac

Mechanical Characteristics

Housing:	PC+ABS UL94 V-0 resin plastic casing, polycarbonate glass, thermoplastic resin
keysDimensions:	front 74x32 mm, depth 59 mm (excluding terminals)
Terminals:	screw/removable terminals for cable with a diameter of 2,5mm ²
Connectors:	TTL for connection to Copy Card
Humidity:	Operating / Storage: 10...90 % RH (not condensing)

Regulations

Electromagnetic compatibility:	This device complies with Directive 2004/108/EC
Security:	This device complies with Directive 2006/95/EC
Food safety:	This device complies with standard EN 13485 as follows: <ul style="list-style-type: none"> - suitable for storage - climate range A - measurement class 1 in the range from -35°C to 25°C (*)

(* exclusively using Eliwell NTC probes)

NOTE: The technical data included in this document, related to measurement (range, accuracy, resolution, etc.) refer to the instrument itself, and not to its equipment such as, for example, sensors. This means, for example, that sensor(s) error(s) shall be added to the instrument's one.

TABLE OF PARAMETERS

PAR.	Liv.	DESCRIPTION
SEt		Temperature SEtpoint.
COMPRESSOR		
diF	1&2	diFferential. Relay compressor tripping differential. The compressor stops on reaching the Setpoint value (as indicated by the adjustment probe), and restarts at temperature value equal to the Setpoint plus the value of the differential. Note: the value 0 cannot be assumed
HSE	1&2	Higher SEt. Maximum possible setpoint value.
LSE	1&2	Lower SEt. Minimum possible setpoint value.
HC	2	The regulator will go to HOT operating mode (set to 'H') or COLD operating mode (set to 'C')
OSP	2	Offset Set Point. Temperature Value to be added to the Set-Point if reduced set is enabled (Economy function).
dOd	2	digital (input) Open door. Digital input that allow you to switch off loads. Valid if H11 = ±4 (door switch). n = does not switch off loads; y = switch off loads.
dAd	2	digital (input) Activation delay. Delay time in activating the digital input.
Ont	2	ON time (compressor). Compressor activation time in the event of faulty probe. If OFt=1 and Ont=0, the compressor is always off, while if OFt=1 and Ont>0 it operated in duty cycle mode.
Oft	2	OFF time (compressor). Compressor deactivation time if probe is faulty. If Ont=1 and OFt=0, the compressor is always on, while if Ont=1 and OFt>0 it operated in duty cycle mode.

dOn	2	delay (at) On compressor. Delay time in activating the compressor relay after switch-on of instrument.
dOF	2	delay (after power) OFF. Delay after switch off; the indicated time must elapse between switch-off of the compressor relay and the successive switch-on.
dbi	2	delay between power-on. Delay between switch-ons; the indicated time must elapse between two successive switch-ons of the compressor.
OdO (!)	2	delay Output (from power) On. Delay time in activating the outputs after switch-on of the instrument or after a power failure.
DEFROST		
dty	1&2	defrost type. Type of defrosting. 0 = electric defrost - compressor off (OFF) during defrosting; 1 = reverse cycle defrost (hot gas); compressor on (ON) during defrosting; 2 = Free defrost; defrosting independently of compressor.
dit	1&2	defrost interval time. Interval between the start of two successive defrosting operations.
dCt	2	defrost Counting type. Selection of count mode for the defrosting interval. 0 = compressor operating hours (DIGIFROST® method); Defrosting active only if compressor is on; 1 = Real Time - equipment operating hours; defrost counting is always active when the machine is on and start everytime the instrument switch on; 2 = compressor stop. Each time the compressor stops a defrosting cycle is performed according to parameter dtY.
dOH	2	defrost Offset Hour. Start-of-defrosting delay time from the call.
dEt	1&2	defrost Endurance time. Defrosting time-out; determines duration of defrosting.
dSt	1&2	defrost Stop temperature. Defrost stop temperature (defined by the evaporator probe).
dPO	2	defrost (at) Power On. Determines if at the start-up the instrument must enter defrosting (if the temperature measured by the evaporator allows this operation). y = yes; n = no.
EVAPORATOR FAN		
Fpt	2	Fan Parameter type. Characterizes the 'FSt' parameter that can be expressed or as an absolute temperature value or as a value related to Setpoint. 0 = absolute 1 = relative.
FSt	1&2	Fan Stop temperature. Fan lock temperature; if the value, read by the evaporator probe, is higher than the set value, fans stop.

FAd	2	FAn differential. Fan starting differential (see par. 'FSt').
Fdt	1&2	Fan delay time. Delay time in activating fans after a defrost operation.
dt	1&2	drainage time. Dripping time.
dFd	1&2	defrost Fan disable. Allows to select the evaporator probes exclusion during defrost. y = yes (fan disable); n = no.
FCO	2	Fan Compressor OFF. Allows to select compressor fans lock OFF (switched off). y = fans activated (with thermostat; based on the value read by the defrost probe, see parameter "FSt"); n = fans off; dc = not used.
Fod	2	Fan open door. Fans active when the door is open. Allows you to select the option of stopping the fans when the door is open, and re-starting the fans when door is closed (if they were active). n = fans stop; y = fans unchanged.

ALARMS		
Att	2	Allow you to select if the parameters HAL and LAL will have absolute (Att=0) or relative (Att=1) value.
AFd	2	Alarm Fan differential. Alarm differential.
HAL	1&2	Higher ALarm. Maximum temperature alarm. Temperature value (in relative value) which if exceeded in an upward direction triggers the activation of the alarm signal.
LAL	1&2	Lower ALarm. Minimum temperature alarm. Temperature value (in relative value), which if exceeded in a downward direction, triggers the activation of the alarm signal.
PAO	2	Power-on Alarm Override. Alarm exclusion time after instrument switch on, after a power failure.
dAO	2	defrost Alarm Override. Temperature alarm exclusion time after defrost.
OAo	2	Alarm signaling delay after digital input disabling (door close). Alarm is only for high-low temperature alarms.
tdO	2	time out door Open. Alarm activation delay time open door.
tAO	1&2	temperature Alarm Override. Temperature alarm signal delay time.
dAt	2	defrost Alarm time. Alarm for defrosting ended due to time out. n = alarm deactivated; y = alarm activated.
EAL	2	External Alarm Clock. External alarm to lock loads (n = don't lock loads; y = lock loads).
COMMUNICATION		
dEA	2	Device address in family (valid values from 0 to 14).
FAA	2	Device family (valid values from 0 to 14). The FAA and dEA values represent the network address of the equipment and are indicated in the following format "FF.DD" (where FF=FAA and DD=dEA).

DISPLAY		
LOC	1&2	LOCK. Setpoint change shutdown. See related paragraph. There is still the possibility to enter into parameters programming and modify these, including the status of this parameter to permit keyboard shutdown. n = no; y = yes.
PS1	1&2	PASsword 1. When enabled (value ≠ 0) it constitutes the access key for level 1 parameters.
PS2	2	PASsword 2. When enabled (value ≠ 0) it constitutes the access key for level 2 parameters.
ndt	2	number display type. View with decimal point. y = yes; n = no.
CA1	1&2	CALibration 1. Positive or negative temperature value added to the value read by probe 1.
CA2	1&2	CALibration 2. Positive or negative temperature value added to the value read by probe 2.
ddl	1&2	defrost display Lock. Viewing mode during defrosting. 0 = shows the temperature read by the room probe; 1 = locks the reading on the temperature value read by room probe when defrosting starts, and until the next time the Setpoint value is reached; 2 = displays the label “dEF” during defrosting, and until the next time the Setpoint value is reached.
dro	2	display read-out. Select °C or °F for displaying the temperature read by the thermostat probe. (0 = °C, 1 = °F). PLEASE NOTE: the switch between °C and °F DO NOT modify setpoint, differential, etc. (for example set=10°C become 10°F)
ddd	2	Selection of type of value to be displayed. 0 = Setpoint; 1 = cold room probe (Pb1); 2 = evaporator probe (Pb2).
CONFIGURATION		
H08	2	Stand-by operating mode. 0 = display switch off; 1 = display switch off, loads and alarms stopped; 2 = display with OFF label, loads and alarms stopped.
H11	2	Configuration of digital inputs/polarity. 0 = disabled; ±1 = defrosting; ±2 = reduced set; ±3 = not used; ±4 = door switch; ±5 = external alarm; ±6 = Stand-by (ON-OFF). ATTENTION!: the “+” sign indicates that the input is activated when the contact is closed. the “-” sign indicates that the input is activated when the contact is open.
H25 (!)	2	Enable/Disable the buzzer. 0 = disabled; 4 = enabled; 1-2-3-5-6 = not used.
H32	2	DOWN button configurability. 0 = disabled; 1 = defrost; 2 = not used; 3 = reduced set; 4 = stand-by.
H42	1&2	Evaporator probe present. n = not present; y = present.
reL	1&2	release firmware. Device version: read only parameter.
tAb	1&2	tAbLe of parameters. Reserved: read only parameter.
COPY CARD		
UL	2	Up load. Programming parameter transfer from instrument to Copy Card.
Fr	2	Format. Erasing all data in the copy card.

(!) WARNING!

- If one or more of these parameters highlighted with (!) are modified, the controller must be switched off and switched on again to ensure correct operation.
- Parameter H25 is present only in model with buzzer on board.

SUPERVISION

The device can be connected to:

- telecontrol system Televis**System** (°)
- **Param**Manager fast parameter setting software

The connection can be made via **TTL** serial port.

For connection to RS-485 bus use TTL/RS485 interface Bus**Adapter 150**.

For connection to PC should be used:

- for Televis**System**: PC**Interface** 1110/1120 with Televis licence;
- for **Param**Manager: PC**Interface** 2150/2250 with **Param**Manager licence;

(°) To configure the instrument for this purpose, use parameters “dEA” and “FAA” in the “Programming” menu.

NOTE: The instrument can be connected to Televis**System** but the RVD function is not available.

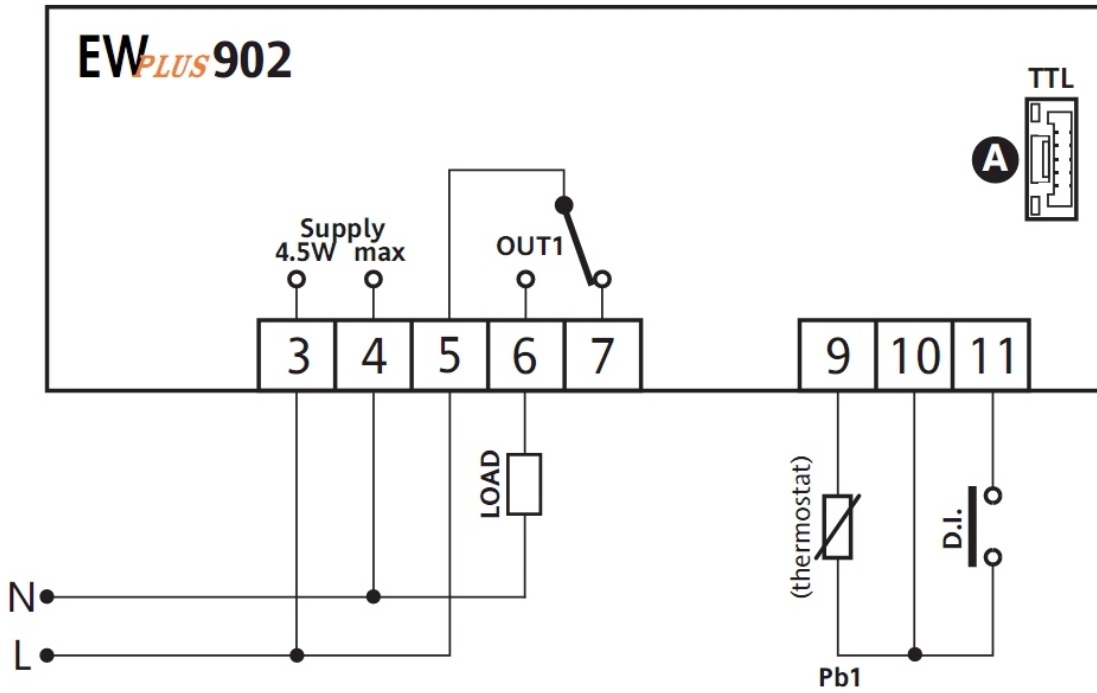

TERMINALS/ MORSETTI/ BORNES/ KLEMMEN

OUT1 regulator relay OUT1 / relè regolatore OUT1 / relais régulateur OUT1 / relais regler OUT1

N-L Power Supply / Alimentazione / Alimentation / Versorgung

A TTL input / Ingresso TTL / Entrée TTL / TTL-Eingang

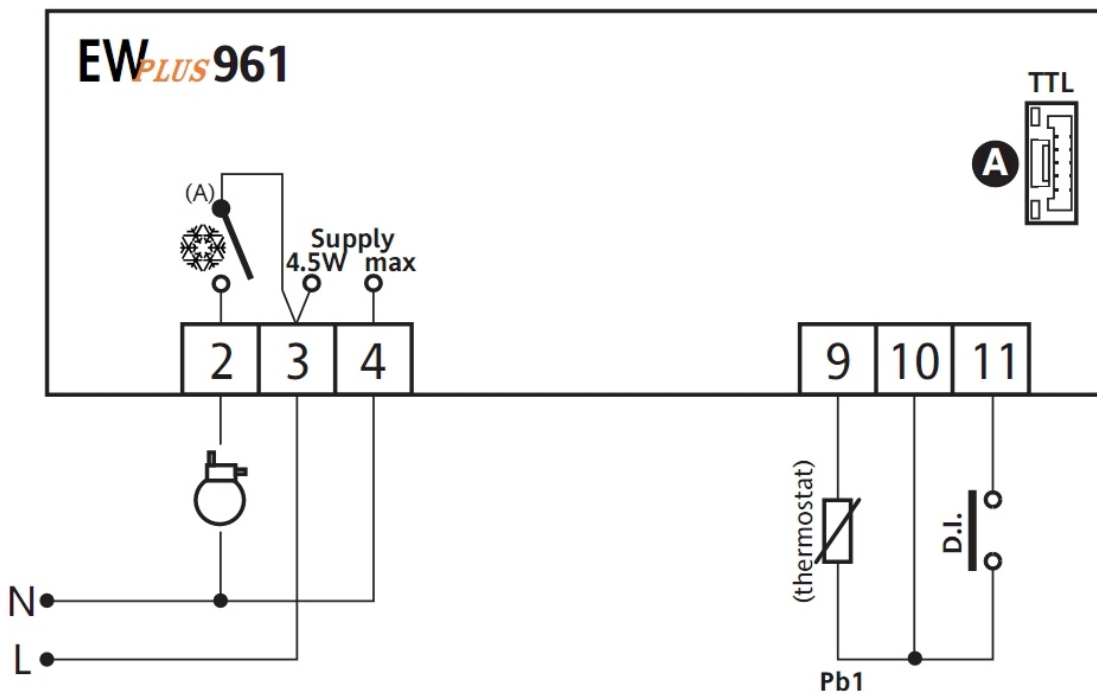

TERMINALS/ MORSETTI/ BORNES/ KLEMMEN

❄️ compressor relay / relè compressore / relais compresseur / Verdichterrelais



N-L Power Supply / Alimentazione / Alimentation / Versorgung

A TTL input / Ingresso TTL / Entrée TTL / TTL-Eingang

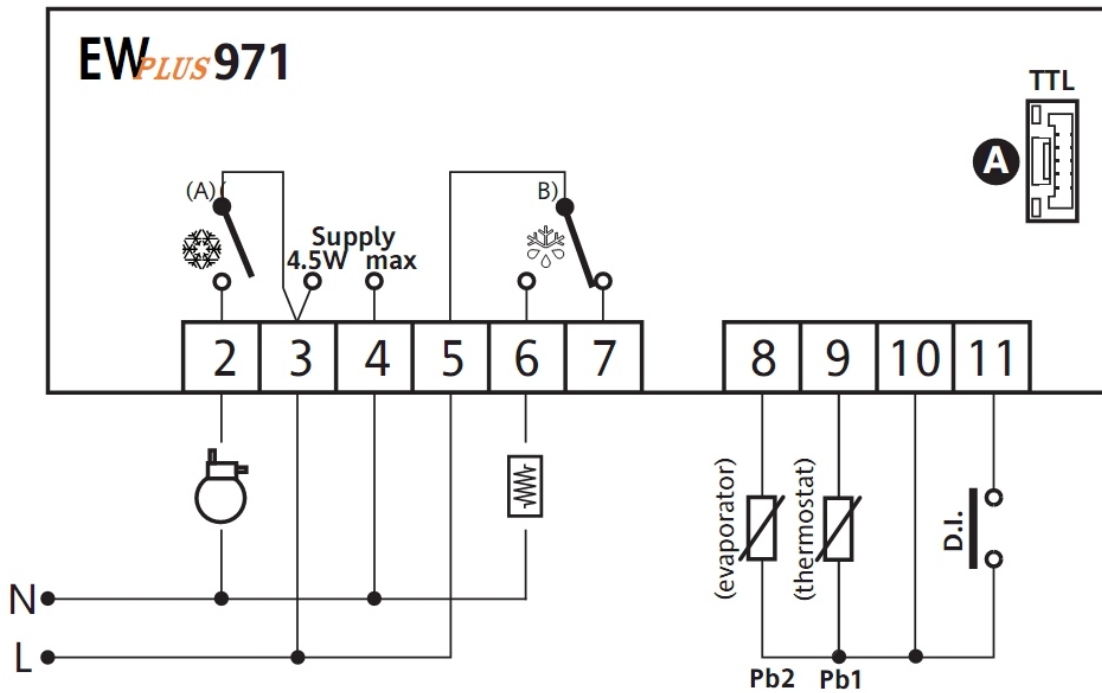





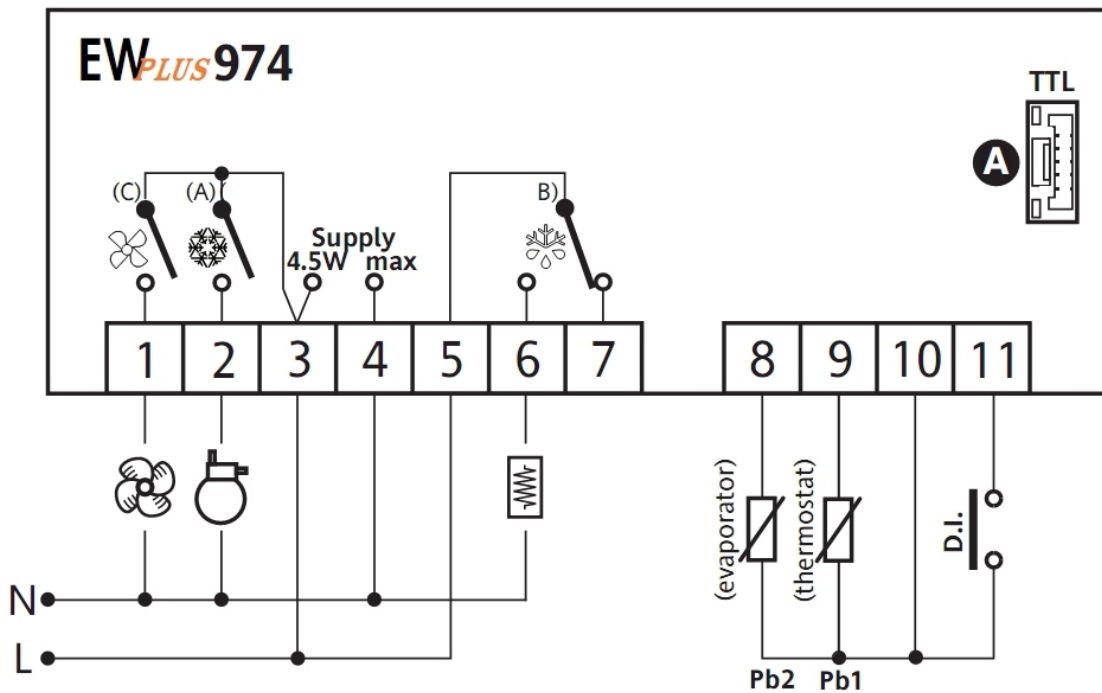

TERMINALS/ MORSETTI/ BORNES/ KLEMMEN

-  defrost relay / relè sbrinamento / relais dégivrage / Abtaurelais
-  compressor relay / relè compressore / relais compresseur / Verdichterrelais
- N-L Power Supply / Alimentazione / Alimentation / Versorgung
- A TTL input / Ingresso TTL / Entrée TTL / TTL-Eingang 



TERMINALS/ MORSETTI/ BORNES/ KLEMMEN

-  defrost relay / relè sbrinamento / relais dégivrage / Abtaurelais
-  compressor relay / relè compressore / relais compresseur / Verdichterrelais
-  fan relay / relè ventole / relais ventilateurs / Gebläserelais
- N-L Power Supply / Alimentazione / Alimentation / Versorgung
- A TTL input / Ingresso TTL / Entrée TTL / TTL-Eingang 

Parameters (Parametri/Paramètres/Parameters) - Default setting

PAR	EW Plus 902/961		EW Plus 971		EW Plus 974		U.M.	Level
	RANGE	DEFAULT	RANGE	DEFAULT	RANGE	DEFAULT		
SEt	-50,0 ... 99,0	0,0	-50,0 ... 99,0	0,0	-50,0 ... 99,0	0,0	°C/°F	
diF	+0,1 ... +30,0	2,0	+0,1 ... +30,0	2,0	+0,1 ... +30,0	2,0	°C/°F	1&2
HSE	LSE ... +230	99,0	LSE ... +230	99,0	LSE ... +230	99,0	°C/°F	1&2
LSE	-55,0 ... HSE	-50,0	-55,0 ... HSE	-50,0	-55,0 ... HSE	-50,0	°C/°F	1&2
HC	H/C	C	---	---	---	---	flag	2
OSP	-30,0 ... +30,0	3,0	-30,0 ... +30,0	3,0	-30,0 ... +30,0	3,0	°C/°F	2
dOd	n/y	n	n/y	n	n/y	n	flag	2
dAd	0 ... 255	0	0 ... 255	0	0 ... 255	0	min	2
Ont	0 ... 250	0	0 ... 250	0	0 ... 250	0	min	2
OfT	0 ... 250	1	0 ... 250	1	0 ... 250	1	min	2
dOn	0 ... 250	0	0 ... 250	0	0 ... 250	0	secs	2
dOF	0 ... 250	0	0 ... 250	0	0 ... 250	0	min	2
dbi	0 ... 250	0	0 ... 250	0	0 ... 250	0	min	2
OdO	0 ... 250	0	0 ... 250	0	0 ... 250	0	min	2
dtY	---	---	0/1/2	0	0/1/2	0	flag	1&2
dit	0 ... 250	6	0 ... 250	6	0 ... 250	6	hours	1&2
dCt	0/1/2	1	0/1/2	1	0/1/2	1	num	2
dOH	0 ... 59	0	0 ... 59	0	0 ... 59	0	min	2
dEt	1 ... 250	30	1 ... 250	30	1 ... 250	30	min	1&2
dSt	---	---	-50,0 ... +150	8,0	-50,0 ... +150	8,0	°C/°F	1&2
dPO	n/y	n	n/y	n	n/y	n	flag	2
Fpt	---	---	---	---	0/1	0	flag	2
FSt	---	---	---	---	-50,0 ... +150	50,0	°C/°F	1&2
FAd	---	---	---	---	+1,0 ... +50,0	2,0	°C/°F	2
Fdt	---	---	---	---	0 ... 250	0	min	1&2
dt	---	---	0 ... 250	0	0 ... 250	0	min	1&2
dFd	---	---	---	---	n/y	y	flag	1&2
FCO	---	---	---	---	n/y	y	flag	2
Fod	---	---	---	---	n/y	n	flag	2
Att	0/1	1	0/1	1	0/1	1	flag	2
AFd	+1,0 ... +50,0	2,0	+1,0 ... +50,0	2,0	+1,0 ... +50,0	2,0	°C/°F	2
HAL	LAL ... +150,0	+50,0	LAL ... +150,0	+50,0	LAL ... +150,0	+50,0	°C/°F	1&2
LAL	-50,0 ... HAL	-50,0	-50,0 ... HAL	-50,0	-50,0 ... HAL	-50,0	°C/°F	1&2

PAR	EW Plus 902/961		EW Plus 971		EW Plus 974		U.M.	Level
	RANGE	DEFAULT	RANGE	DEFAULT	RANGE	DEFAULT		
PAO	0 ... 10	0	0 ... 10	0	0 ... 10	0	hours	2
dAO	0 ... 999	0	0 ... 999	0	0 ... 999	0	min	2
OAO	0 ... 10	0	0 ... 10	0	0 ... 10	0	hours	2
tdO	0 ... 250	0	0 ... 250	0	0 ... 250	0	min	2
tAO	0 ... 250	0	0 ... 250	0	0 ... 250	0	min	1&2
dAt	---	---	n/y	n	n/y	n	flag	2
EAL	n/y	n	n/y	n	n/y	n	flag	2
dEA	0 ... 14	0	0 ... 14	0	0 ... 14	0	num	2
FAA	0 ... 14	0	0 ... 14	0	0 ... 14	0	num	2
LOC	n/y	n	n/y	n	n/y	n	flag	1&2
PS1	0 ... 250	0	0 ... 250	0	0 ... 250	0	num	1&2
PS2	0 ... 250	15	0 ... 250	15	0 ... 250	15	num	2
ndt	n/y	y	n/y	y	n/y	y	flag	2
CA1	-12,0 ... +12,0	0,0	-12,0 ... +12,0	0,0	-12,0 ... +12,0	0,0	°C/°F	1&2
CA2	---	---	-12,0 ... +12,0	0,0	-12,0 ... +12,0	0,0	°C/°F	1&2
ddl	0/1/2	1	0/1/2	1	0/1/2	1	num	1&2
dro	0/1	0	0/1	0	0/1	0	flag	2
ddd	0/1/2	1	0/1/2	1	0/1/2	1	num	2
H08	0/1/2	2	0/1/2	2	0/1/2	2	num	2
H11	-6 ... +6	0	-6 ... +6	0	-6 ... +6	0	num	2
H25 (!)	---	---	---	---	0 ... 6	4	num	2
H32	0 ... 4	0	0 ... 4	0	0 ... 4	0	num	2
H42	---	---	n/y	y	n/y	y	flag	1&2
rEL	/	/	/	/	/	/	/	1&2
tAb	/	/	/	/	/	/	/	1&2
UL	/	/	/	/	/	/	/	2
Fr	/	/	/	/	/	/	/	2

(!) WARNING/ ATTENZIONE/ ACHTUNG/ ATTENTION!

Parameter H25 is present only in model with buzzer on board.

Il parametro H25 è presente solo nei modelli dotati di buzzer a bordo.

Der Parameter H25 ist nur in den Modellen mit eingebautem Summer vorhanden

Le paramètre H25 est présent uniquement sur les modèles doués de buzzer à bord.